

■ **STANDART SERİ / STANDARD SERIES**

BFRL Standart Seri 2'li Şartlandırıcı Standard Series Double F.R.L Combination

BLUETECH	B FRL 14	Bağlantı Ölçüsü Port Size 14 : 1/4" 12 : 1/2"
	Model Model	

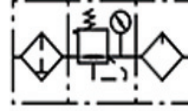

*Aşağıda görüldüğü gibi 1/2" modelinde kavanoz koruyucular bulunmaktadır.

Özellikler / Specifications

Model Model		BFRL 14	BFRL 12
Özellikler Specifications			
Akışkan Fluid		Hava Air	
Bağlantı Ölçüsü (Rc) Port Size		1/4"	1/2"
Çalışma Basınç Aralığı (Bar) Oper. Press. Range		0,5-8,5	
Max.Çalışma Basıncı (Bar) Max. Oper. Pressure		10	
Çalışma Sıcaklık Aralığı (oC) Oper. Temp. Range		5-60	
Filtreleme Kapasitesi Filtering Grade		40 µ	
Akaç Drain		Yarı Otomatik Akaç Semi-automatic drain	
Malzeme Material	Ana Ünite Body	Alüminyum Döküm Aliminum die-cast	
	Kavanoz Bowl	Polikarbonat Polycarbonate	
Parçalar Parts	Filtre Regülatör Filter Regulator	BFR 14	BFR 12
	Regülatör Regulator	BR 14	BR 12
	Yağlayıcı Lubricator	BL 14	BL 12



■ **FILTER REGULATOR**
FILTRE REGÜLATÖR

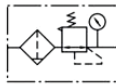

■ **LUBRICATOR**
YAĞLAYICI



■ **REGULATOR**
REGÜLATÖR

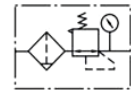

Model Model		BR 14	BR 12
Özellikler Specifications			
Akışkan Fluid		Hava Air	
Bağlantı Ölçüsü (Rc) Port Size		1/4"	1/2"
Çal. Bas. Aralığı (Bar) Oper. Press. Range		0,5-8,5	
Max. Çal. Basıncı (Bar) Max. Oper. Press.		10	
Çalışma Sıc. Aralığı (oC) Oper. Temp. Range		5-60	
Malzeme Material	Ana Ünite Body	Plastik Plastic	

■ DRAWINGS

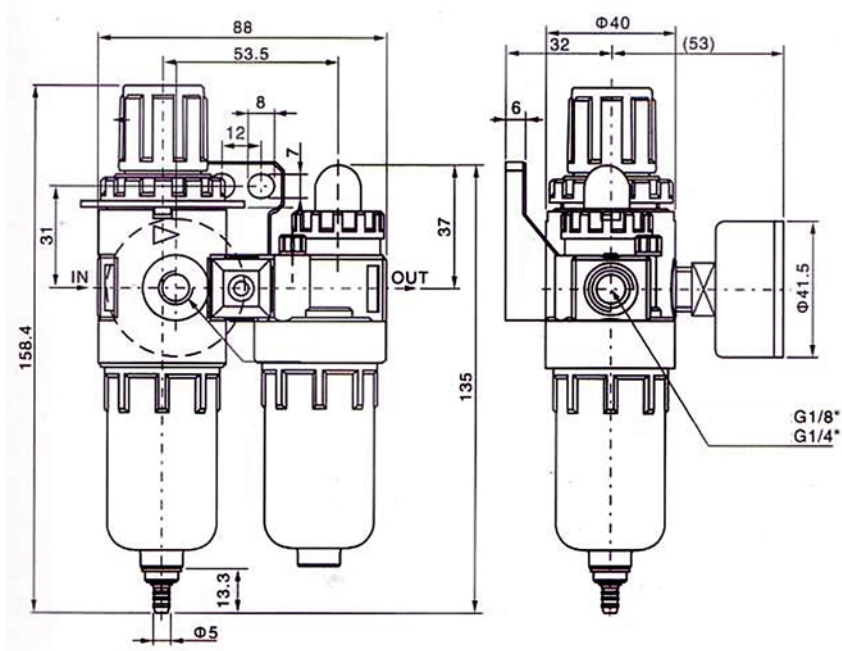

Özellikler / Specifications

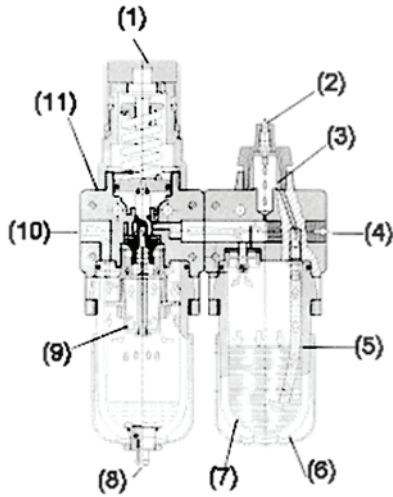

- 1- Knob with Snap-lock Prevents Accidental Adjustment
- 2- Precision Oil Adjustment
- 3- Large Fill Port
- 4- Air Outlet
- 5- Flexible Siphon Tube
- 6- Metal Bowl Guard
- 7- Transparent Plastic Bowl
- 8- Semi-auto Drain
- 9- Brass Filter Element
- 10- Air Inlet
- 11- Relief Port

- The filter with water separator removes dirt, pipe scale, rust and condense from the compressed air.
- The regulator adjusts the supply air to the set working pressure and evens out pressure fluctuations.
- The lubricator supplies the compressed air with a finely metered quantity of oil.
- The Inlet of compressed air can be mounted on either on right or left side.
- The filter, regulator and lubricator are also available separately.

■ **ÖZEL SERİ / SPECIAL SERIES**

BSFRL Özel Seri 2'li Şartlandırıcı Special Series Double F.R.L Combination

BLUETECH	B SFRL 14	Bağlantı Ölçüsü Port Size 14 : 1/4" 12 : 1/2" 34 : 3/4" 11 : 1/1"
	Model Model	

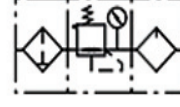

Özellikler / Specifications

Model Model		BFRL 14	BFRL 12	BSFRL 34	BSFRL 11
Özellikler Specifications					
Akışkan Fluid		Hava Air			
Bağlantı Ölçüsü (Re) Port Size		1/4"	1/2"	3/4"	1/1"
Çalışma Basınç Aralığı (Bar) Oper. Press. Range		0,5-8,5			
Max.Çalışma Basıncı (Bar) Max. Oper. Pressure		10			
Çalışma Sıcaklık Aralığı (oC) Oper. Temp. Range		5-60			
Filtreleme Kapasitesi Filtering Grade		25 µ			
Akaç Drain		Yarı Otomatik Akaç Semi-automatic drain			
Malzeme Material	Ana Ünite Body	Alüminyum Döküm Aliminum die-cast			
	Kavanoz Bowl	Polikarbonat Polycarbonate			
Parçalar Parts	Filtre Regülatör Filter Regulator	BSFR 14	BSFR 12	BSFR 34	BSFR 11
	Filtre Filter	BSF 14	BSF 12	BSF 34	BSF 11
	Regülatör Regulator	BSR 14	BSR 12	BSR 34	BSR 11
	Yağlayıcı Lubricator	BSL 14	BSL 12	BSL 34	BSL 11

■ **FILTER REGULATOR**
FİLTRE REGÜLATÖR



■ **FILTER**
FİLTRE

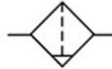

■ **LUBRICATOR**
YAĞLAYICI



■ **REGULATOR**
REGÜLATÖR

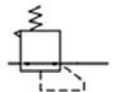

Model Model		BR 14	BR 12	BSR 34	BSR 11
Özellikler Specifications					
Akışkan Fluid		Hava Air			
Bağlantı Ölçüsü (Re) Port Size		1/4"	1/2"	3/4"	1/1"
Çal. Bas. Aralığı (Bar) Oper. Press. Range		0,5-8,5			
Max. Çal. Basıncı (Bar) Max. Oper. Press.		9,5			
Çalışma Sıc. Aralığı (oC) Oper. Temp. Range		5-60			
Malzeme Material	Ana Ünite Body	Al. Döküm Al. die-casting			
	Kavanoz Bowl	Polikarbonat Polycarbonate			

■ **ÖZEL SERİ / SPECIAL SERIES**

BSF-R-L Özel Seri 3'lü Şartlandırıcı Special Series Triple F.R.L Combination

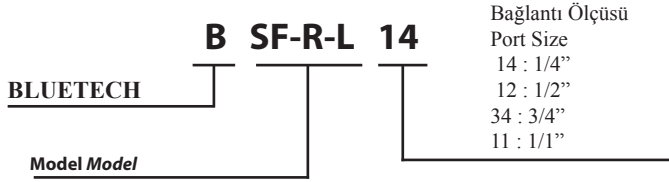

Özellikler / Specifications

Model Model		BSF-R-L 14	BSF-R-L 12	BSF-R-L 34	BSF-R-L 11
Özellikler Specifications					
Akışkan Fluid		Hava Air			
Bağlantı Ölçüsü (Rc) Port Size		1/4"	1/2"	3/4"	1/1"
Çalışma Basınç Aralığı (Bar) Oper. Press. Range		0,5-8,5			
Max.Çalışma Basıncı (Bar) Max. Oper. Pressure		9,5			
Çalışma Sıcaklık Aralığı (0C) Oper. Temp. Range		5-60			
Filtreleme Kapasitesi Filtering Grade		25 µ			
Akaç Drain		Yarı Otomatik Akaç Semi-automatic drain			
Malzeme Material	Ana Ünite Body	Alüminyum Döküm Aliminum die-cast			
	Kavanoz Bowl	Polikarbonat Polycarbonate			
Parçalar Parts	Filtre Regülatör Filter Regulator	BSF-R 14	BSF-R 12	BSF-R 34	BSF-R 11
	Filtre Filter	BS-F 14	BS-F 12	BS-F 34	BS-F 11
	Regülatör Regulator	BS-R 14	BS-R 12	BS-R 34	BS-R 11
	Yağlayıcı Lubricator	BS-L 14	BS-L 12	BS-L 34	BS-L 11



■ **FILTER REGULATOR**
FİLTRE REGÜLATÖR

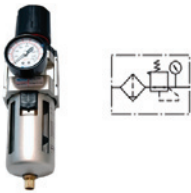

■ **FILTER**
FİLTRE



■ **LUBRICATOR**
YAĞLAYICI



■ **REGULATOR**
REGÜLATÖR

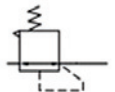

Model Model		BSR 14	BSR 12	BSR 34	BSR 11
Özellikler Specifications					
Akışkan Fluid		Hava Air			
Bağlantı Ölçüsü (Rc) Port Size		1/4"	1/2"	3/4"	1/1"
Çal. Bas. Aralığı (Bar) Oper. Press. Range		0,5-8,5			
Max. Çal. Basıncı (Bar) Max. Oper. Press.		9,5			
Çalışma Sıc. Aralığı (0C) Oper. Temp. Range		5-60			
Malzeme Material	Ana Ünite Body	Al. Döküm Al. die-casting			
	Kavanoz Bowl	Polikarbonat Polycarbonate			

Filtre / Yağlayıcı Hazneleri Filter / Lubricator Bowl

BLUETECH

F : Standart Seri Filtre Standard Series Filter
 L : Standart Seri Yağlayıcı Standard Series Lubricator
 SF : Özel Seri Filtre Special Series Filter
 SL : Özel Seri Yağlayıcı Special Series Lubricator

B ---- H 12

Diş Ölçüsü Port Size
 14 : 1/4"
 12 : 1/2"
 34 : 3/4"
 11 : 1/1"

Model Model



BD Regülör Diyaframları Regulator Diaphragm

BLUETECH

S : Özel Seri Special Series

B ---- D 12

Diş Ölçüsü Port Size
 14 : 1/4"
 12 : 1/2"
 34 : 3/4"
 11 : 1/1"

Model Model



DRAWINGS

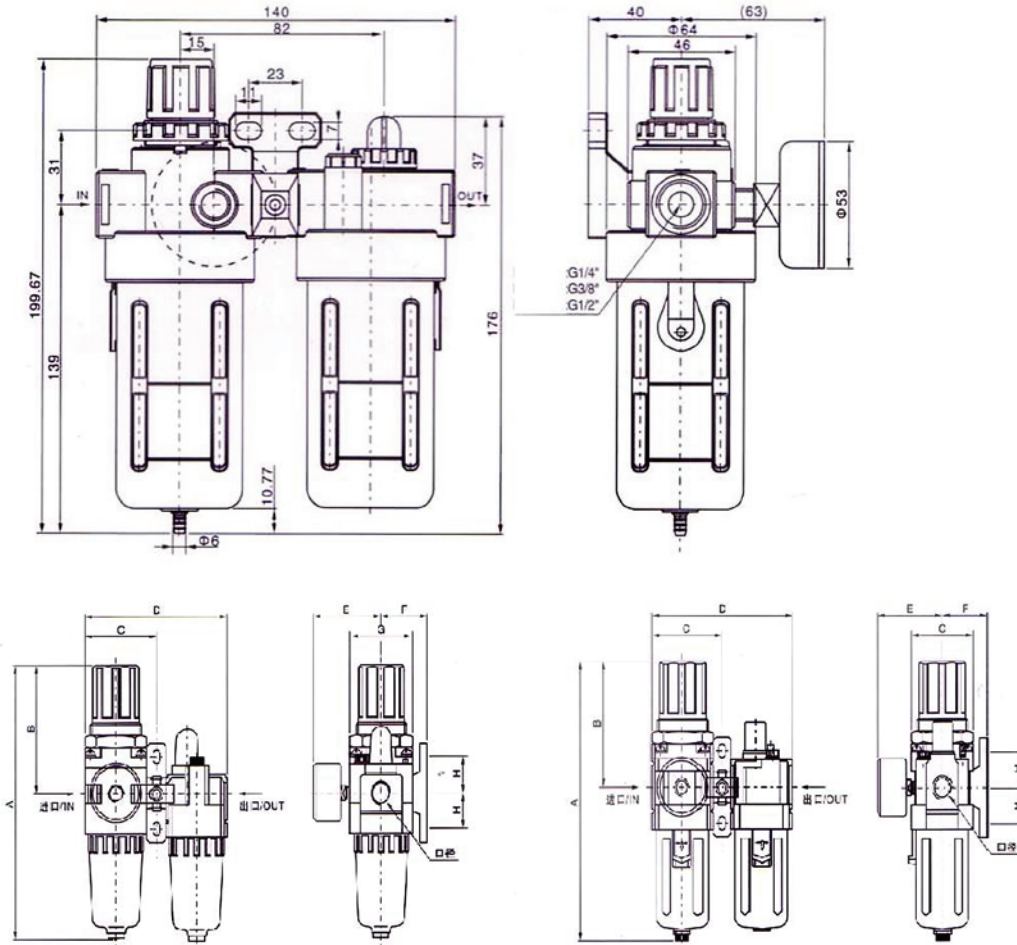

Bore	A	B	C	D	E	F	G	H
M5	109.5	50.5	29	58	26	25	25	20
1/8-1/4	164.5	78	45	90	56.8	30	40	24
1/4-3/8	211	92.5	58.5	117	60.8	41	53	35
3/8-1/2	262	112	77	154	70.5	41	70	40
3/4	267	114	82	164	70.5	50	70	40
3/4-1	338	116	97.5	195	75.5	69.8	90	50

■ **N - SERİ / N SERIES**

BFRL12N Serisi 2'li Şartlandırıcı / N Series Double FR+L Combination

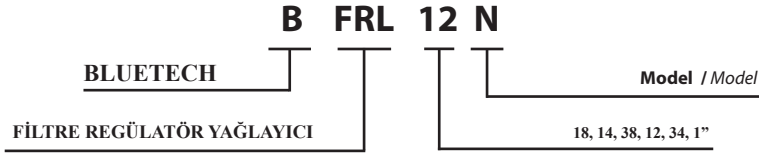

Özellikler / Specifications

Model Model		BFRL 18 N	BFRL 14 N	BFRL 38 N	BFRL 12 N	BFRL 34 N	BFRL 1"
Özellikler Specifications							
Akışkan Fluid		Hava Air					
Bağlantı Ölçüsü (Re) Port Size		1/8"	1/4"	3/8"	1/2"	3/4"	1"
Çalışma Basınç Aralığı (Bar) Oper. Press. Range		0,5-8,5					
Max.Çalışma Basıncı (Bar) Max. Oper. Pressure		15					
Çalışma Sıcaklık Aralığı (0C) Oper. Temp. Range		0-60					
Filtreleme Kapasitesi Filtering Grade		5 µ or 40 µ					
Akaç Drain		Yarı Otomatik Akaç Semi-automatic drain					
Malzeme Material	Ana Ünite Body	Plastik / Plastic					
	Kavanoz Bowl	Polikarbonat / Polycarbonate					
Parçalar Parts	Filtre Regülatör Filter Regulator	BFRL 18 N	BFRL 14 N	BFRL 38 N	BFRL 12 N	BFRL 34 N	BFRL 1" N
	Filtre Filter	BF18 N	BF14 N	BF38 N	BF12 N	BF34 N	BF1" N
	Regülatör Regulator	BR18 N	BR14 N	BR38 N	BR12 N	BR34 N	BR1" N
	Yağlayıcı Lubricator	BL18 N	BL14 N	BL38 N	BL12 N	BL34 N	BL1" N

■ **REGULATOR**
REGÜLATÖR

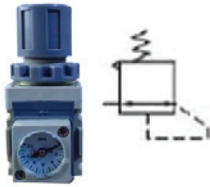

■ **FILTER REGULATOR**
FİLTRE REGÜLATÖR

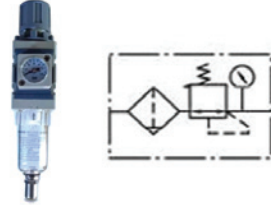

■ **FILTER**
FİLTRE

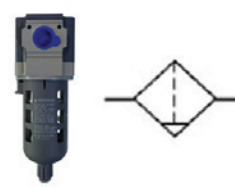

■ **LUBRICATOR**
YAĞLAYICI

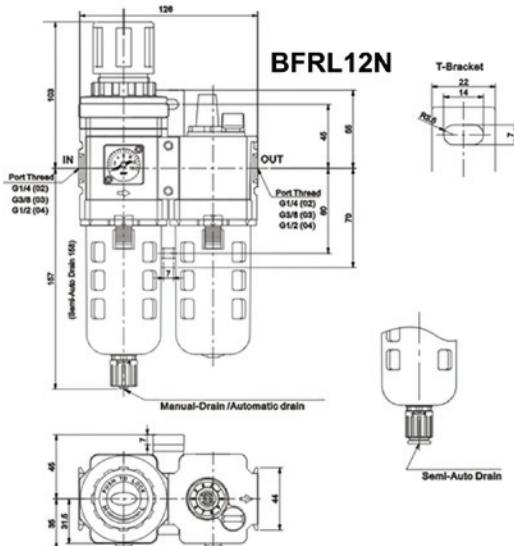
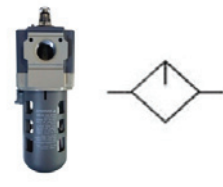

BFRL12N

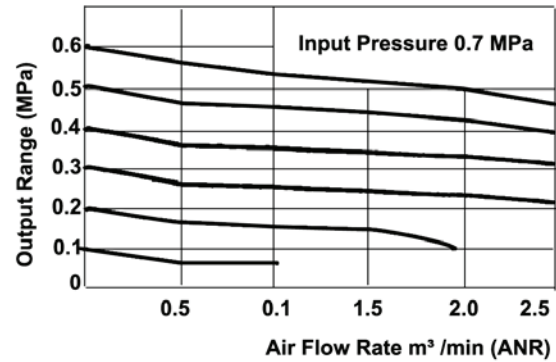

Note: Manual drain or automatic drain can insert ID ø 5.5 PU tube at drain outlet. Semi-Auto drain can insert ID ø 8PU tube at drain outlet.